

ACR10RH

General

The guide-rail harmonic meter with external roche coil and open type mutual inductor is suitable for energy saving renovation projects in high energy consumption industries such as smelting, steel, electric welding, semiconductor, etc. And also for power monitoring of distributed photovoltaic grid-connected cabinet, power demand side management and other applications. The utility model has the advantages of no need to remove primary bus, simple and convenient wiring, safe construction, saving transformation cost and improving efficiency for users. It integrates the measurement of all power parameters (such as current, voltage, active power, reactive power, apparent power, frequency, power factor, etc.), multi-rate electric energy measurement, four-quadrant electric energy measurement, harmonic analysis and electric energy monitoring and assessment management. At the same time, it has a variety of peripheral interface for user to choose: with RS485 communication interface, modbus-rtu protocol can meet the needs of communication network management; The function of "remote signal" and "remote control" of circuit breaker switch can be realized with switch quantity input and relay output. LCD display interface is adopted to realize parameter setting and control through panel keys, which is very suitable for real-time power monitoring system.



Model Description

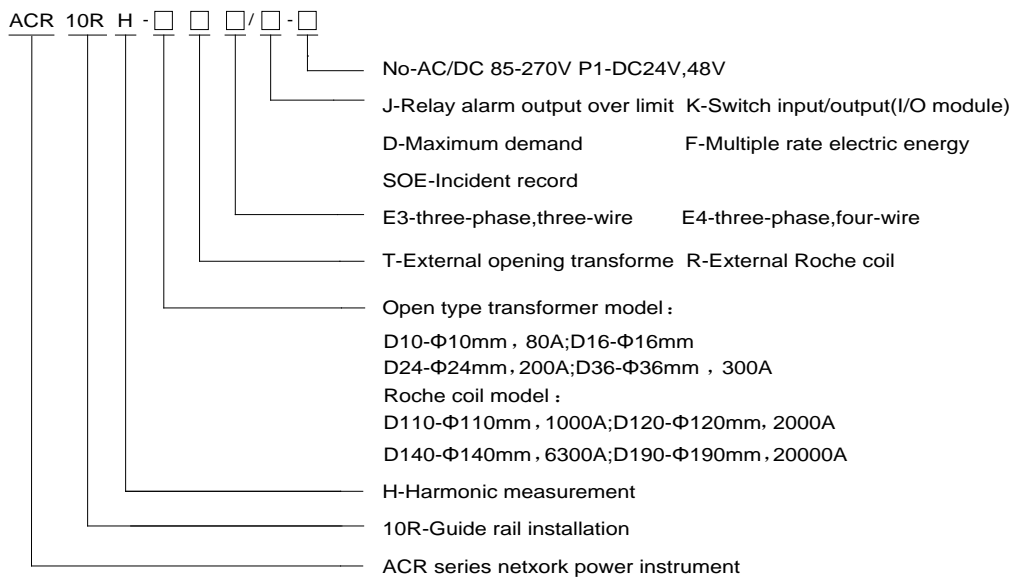

Function

Function		Model	ACR10RH-DxxT(R)E4 ACR10RH-DxxT(R)E3
Display mode	LCD (Field LCD)		■
Measuring parameter	Current/voltage/frequency/power factor		■
	Active power/reactive power/apparent power		■
	Four quadrant electric energy measurement		■
	Maximum demand		□
	Multiple rate electric energy measurement		□
Power quality monitoring	Total harmonic content		■
	subharmonic (2-31 times)		■
Data logging	Incident record		□

Function		Model	ACR10RH-DxxT(R)E4 ACR10RH-DxxT(R)E3
Display mode	Alarm		□
	Built-in clock		□
Communication	RS485 interface		■
Optional function (choose one)	J (2DO)		A1+ (B1 or C1) (4DI+2DO or 4DI+EP)*
	K (4DI)		
	pulse (2channels)		

- Note:1、“■”is standard allocation function, “□”is matching function, Above instrument stanfard 1 channel RS485 communication;
 2、 Terminal connection mode corresponding to A1/B1/C1 and so on in selection function;
 3、 Pulse output and relay output can not be selected at the same time;
 4、 When you select an event loggong feature,you must configure the DI or DO

Technical parameter

Technical parameters			Indicators	
Input	Net work		3-phase 3-wire,3-phase 4 wire	
	Frequency		45~65Hz	
	Voltage		Rating: AC 57.7V/100V(100V)、220V/380V(400V)	
			Overload:1.2-fold rating(continuous);2-fold rating/1second Consumption:<0.2VA	
Current		Rating: 80A, 120A, 200A .etc (See specific product specifications,special parameters can be customized)		
		Overload:1.2-fold rating(continuous);10-fold rating/1 second		
		Consumption: < 0.2VA		
Output	Electric energy		Output mode:Open-collector photocoupler pulse,two way output Three-phase Pulse constant:4000、8000imp/kWh	
	Communication		RS485 interface,Modbus-RTU Protocol	
	Display mode		LCD	
Function	Switching	Input	Four way dry contact input	
		Output	Output mode: two way relay nO contact output Contact capacity: AC 250V/3A、DC 30V/3A	
Measuring accuracy			Frequency0.05Hz、 reactive electric energy1class、 other 0.5class	
Power supply			AC85~265V or DC100~350V; DC24V (±10%) ; DC48V (±10%) Consumption≤10VA	
Safety	Power-frequency withstand voltage		Power frequency withstand voltage between Auxiliary power and switch volume output and current input and voltage input and communication and pulse output and switch volume input terminal is AC2kV 1min; Power frequency withstand voltage between auxiliary power and switch volume output and current input voltage input terminal is AC 2kV/1min;Power frequency withstand voltage between communication and pulse output and switch volume input terminal is AC 1kV/1min;	
	Insulation resistance		Input,Output terminal to housing>100MΩ	
Environment			Working temperature: -10℃~+55℃; Storage temperature: -20℃~+70℃ Relative humidity: 5%~95% No condensation; Altitude: ≤2500m	

Dimension

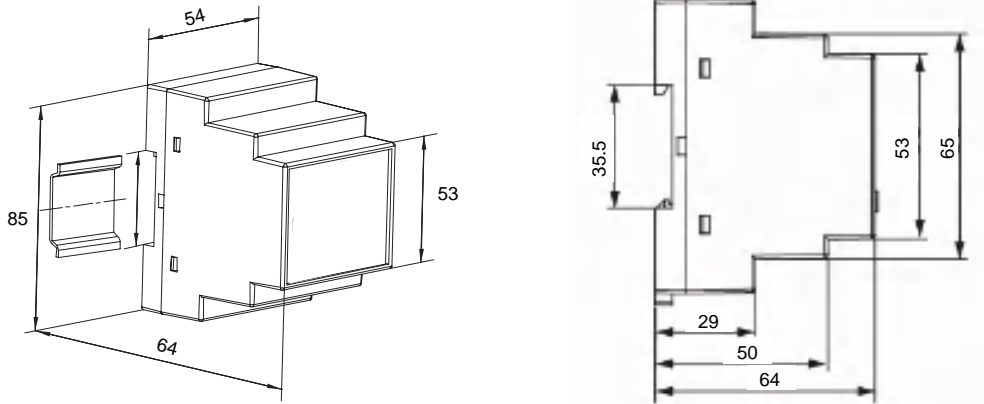

Wiring

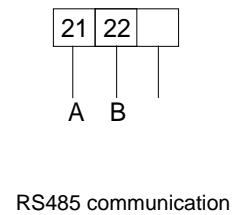
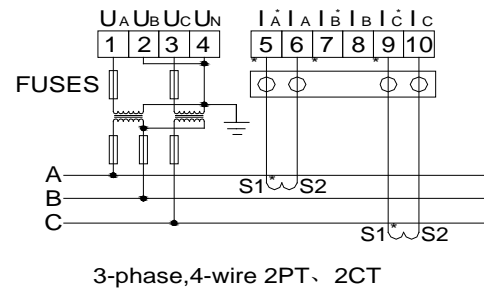
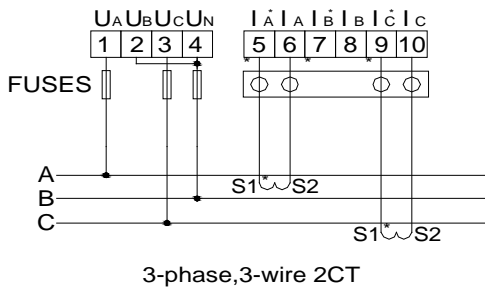
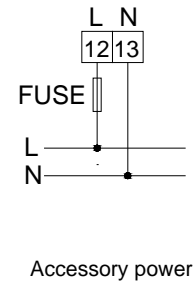
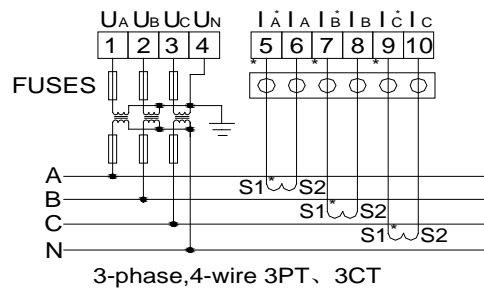
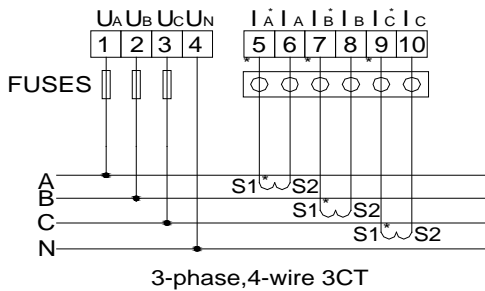

	A1					
A	<table border="1"> <tr> <td>24</td> <td>25</td> <td>26</td> <td>27</td> <td>28</td> </tr> </table> <p>DI₁ DI₂ DI₃ DI₄ Switch input (4DI)</p>	24	25	26	27	28
24	25	26	27	28		
B	<table border="1"> <tr> <td>34</td> <td>35</td> <td>36</td> </tr> </table> <p>DO₁ DO₂ Switch output (2DO)</p>	34	35	36		
34	35	36				
C	<table border="1"> <tr> <td>17</td> <td>18</td> <td>19</td> </tr> </table> <p>E_p⁺ E_q E₋ 2 pulse (2EP)</p>	17	18	19		
17	18	19				

Note: It is a test terminal for CT secondary side short connection.

When three-phase three-wire connection is made, no.2 terminal and no.4 terminal shall be externally connected together

The fuse in the wiring diagram is recommended 0.5A or 3A.

When the instrument is installed on site, it must correspond to the supporting open and closed transformer or roche coil one by one, otherwise the measurement accuracy will be affected, and the connection between the two must be reliable.

Operation

The five keys of the instrument from left to right are:FN、SET、▲、▶、ENTER。

FN button	The button function is not open yet
SET button	Under measuring mode , press this key to enter the setting interface; Under programming mode,this button is used for return to previous menu;
▲	Under measuring mode,press this button can page up the display items , see the display menu for related parameters; Under programming mode , used to toggle peer menus or single digit reductions。
▶	Under measuring mode,press this button can page down the display items , see the display menu for related parameters; Under programming mode,used to toggle peer menus or single digit increments。
Enter button	Under programming mode,this button is used for confirming selection of menu item and revision of parameter